

SSM P/N CPG14446

NTK

LATEST REVISION S DESCRIPTION	

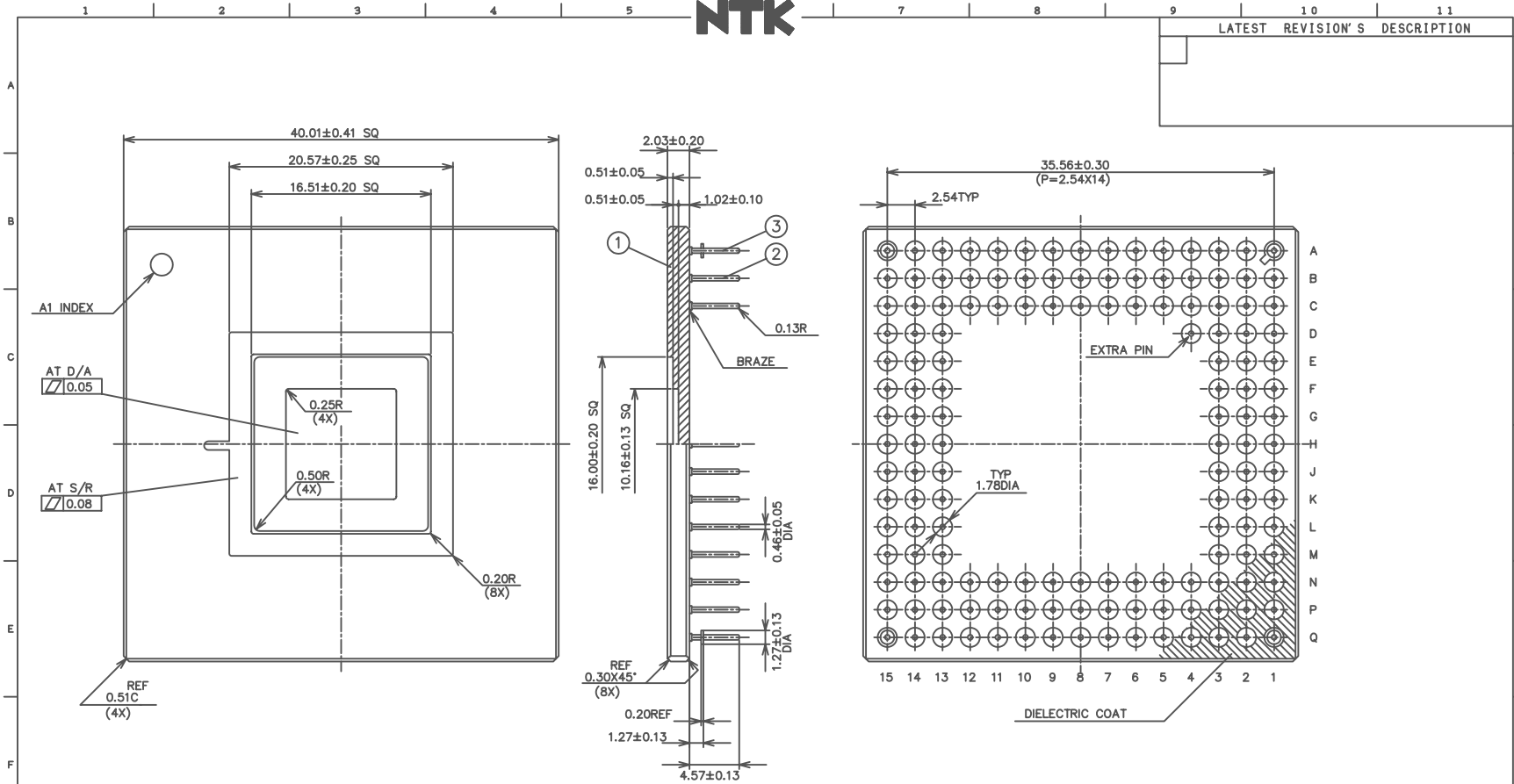

- NOTES:
- GOLD PLATE 1.5µm MIN OVER 2.0µm MIN NICKEL.
 - LEAD RESISTANCE: NO.18,19,54,55,90,91,126,127----250mΩMAX.
NO.1,37,73,109 ----300mΩMAX.
OTHERS ---- 900mΩMAX.
 - D4 PIN(EXTRA PIN) TO BE ELECTRICALLY CONNECTED TO D3 PIN.
 - SEAL RING AND DIE ATTACH PAD TO BE FLOATING FROM ANY PINS.

③	STAND OFF PIN	ALLOY42			
②	PIN	ALLOY42			
①	CERAMIC	BLACK ALUMINA			
Item	Name	Material	Description	Rev.	Description
UNLESS OTHERWISE SPECIFIED			DRAWN	N.KAWAI	NEW DRAWING
TOLERANCES: ± 1 %			CHECKED		
N. L. T. 1 DECIMALS X.X ± 0.25					FEB-19
2 DECIMALS X.XX ± 0.13					-1990
CUSTOMER		APPROVED	TITLE		
DWG NO.		UNIT <u>MM</u>	NGK SPARK PLUG CO., LTD.		
		SCALE	144 PIN PLUG IN PACKAGE		
			DWG NO.		
			IPKX4F1-8573A		

MODIFIED
DWG NO.

PART NO. SHEET 1 OF 2



SSM P/N CPG14446

NTK

REV.	DATE	DESCRIPTION

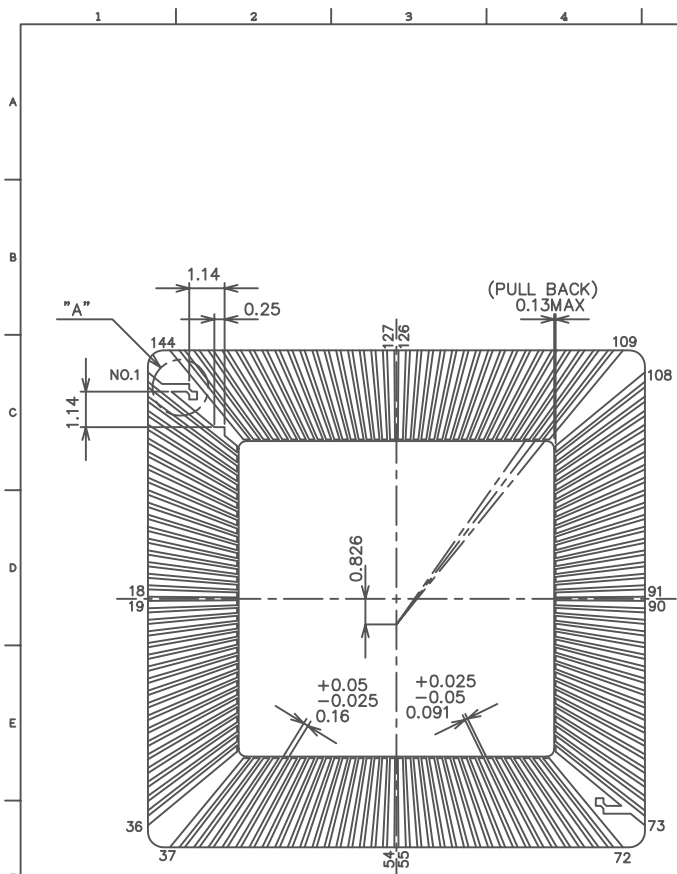

CONNECTION TABLE

PAD	PIN	PAD	PIN	PAD	PIN	PAD	PIN	PAD	PIN	PAD	PIN
1	D3	25	L1	49	N7	73	M13	97	E15	121	C9
2	C2	26	L2	50	Q6	74	N14	98	E14	122	A10
3	B1	27	M1	51	Q7	75	P15	99	D15	123	A9
4	D2	28	N1	52	P8	76	M14	100	C15	124	B8
5	E3	29	M2	53	Q8	77	L13	101	D14	125	A8
6	C1	30	L3	54	N8	78	N15	102	E13	126	C8
7	E2	31	N2	55	N9	79	L14	103	C14	127	C7
8	D1	32	P1	56	Q9	80	M15	104	B15	128	A7
9	F3	33	M3	57	Q10	81	K13	105	D13	129	A6
10	F2	34	N3	58	P9	82	K14	106	C13	130	B7
11	E1	35	P2	59	P10	83	L15	107	B14	131	B6
12	G2	36	Q1	60	N10	84	J14	108	A15	132	C6
13	G3	37	N4	61	Q11	85	J13	109	C12	133	A5
14	F1	38	P3	62	P11	86	K15	110	B13	134	B5
15	G1	39	Q2	63	Q12	87	J15	111	A14	135	A4
16	H2	40	P4	64	Q13	88	H14	112	B12	136	A3
17	H1	41	N5	65	P12	89	H15	113	C11	137	B4
18	H3	42	Q3	66	N11	90	H13	114	A13	138	C5
19	J3	43	P5	67	P13	91	G13	115	B11	139	B3
20	J1	44	Q4	68	Q14	92	G15	116	A12	140	A2
21	K1	45	N6	69	N12	93	F15	117	C10	141	C4
22	J2	46	P6	70	N13	94	G14	118	B10	142	C3
23	K2	47	Q5	71	P14	95	F14	119	A11	143	B2
24	K3	48	P7	72	Q15	96	F13	120	B9	144	A1

B/G PADS DETAIL

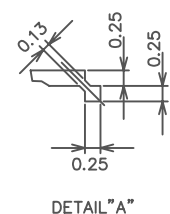

MODIFIED DWG NO. 1

UNLESS OTHERWISE SPECIFIED TOLERANCES: ± 1% N. L. T. 1 DECIMALS X.X ± 0.25 2 DECIMALS X.XX ± 0.13	DRAWN	N.KAWAI	NEW DRAWING	FEB-19
	CHECKED		Description	-1990
	APPROVED		Rev.	Date
	CUSTOMER		NGK SPARK PLUG CO., LTD.	
DWG NO.	UNIT	MMM	TITLE	B/G PADS DETAIL & CONNECTION TABLE
	SCALE	/	DWG NO.	IPKX4F1-8573A

PART NO. SHEET 2 OF 2



SSM P/N CPG14446

NTK

9	10	11
LATEST REVISION'S		DESCRIPTION

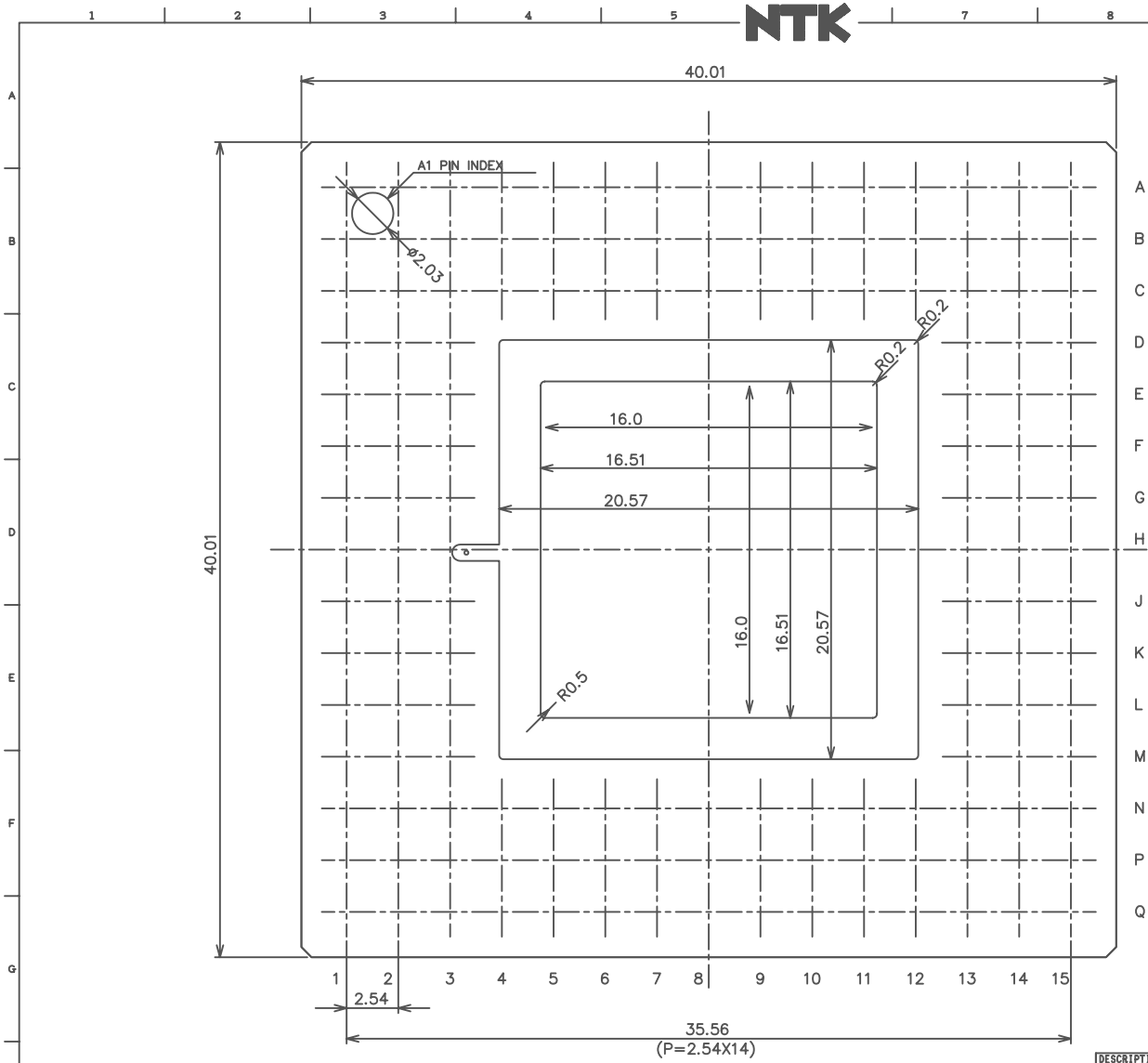

	NEW DRAWING	FEB-19
Rev.	Description	Date

DESCRIPTION	DRAWN	NTK
FILE NAME	CHECKED	N.KAWAI
CUSTOMER	APPROVED	NTK
DWG NO.	UNIT	MM [INCH]
	SCALE	
	DWG NO.	P-IPK-8573A-3A

MODIFIED	
DWG NO.	

DESCRIPTION	DRAWN	NTK
FILE NAME	CHECKED	N.KAWAI
CUSTOMER	APPROVED	NTK
DWG NO.	UNIT	MM [INCH]
	SCALE	
	DWG NO.	P-IPK-8573A-3A

PART NO.	SHEET	OF
----------	-------	----



SSM P/N CPG14446

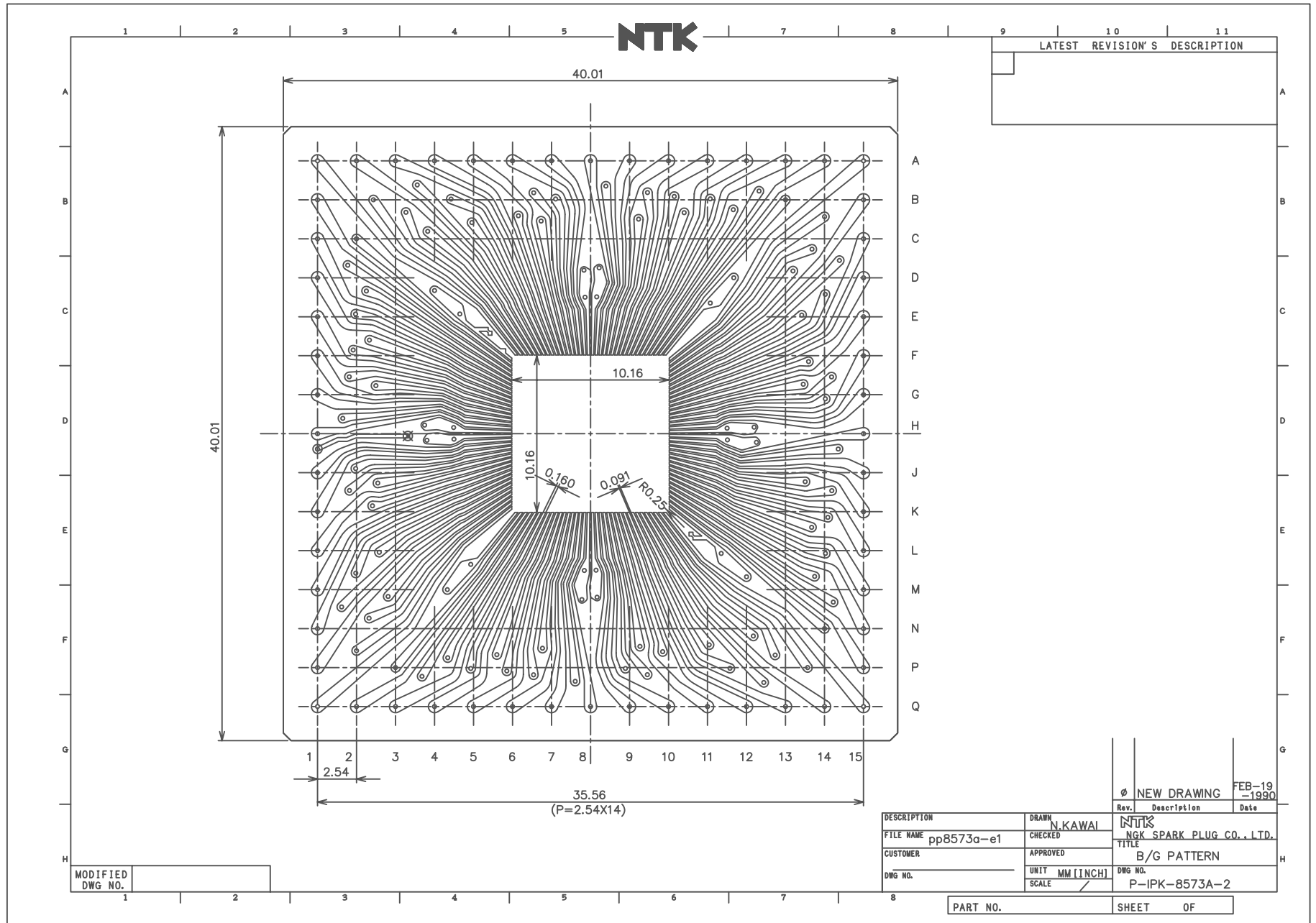

NTK

9	10	11
LATEST REVISION'S		DESCRIPTION

MODIFIED	
DWG NO.	

DESCRIPTION	DRAWN	DATE
FILE NAME	CHECKED	
CUSTOMER	APPROVED	
DWG NO.	UNIT	DWG NO.
	SCALE	

	NEW DRAWING	FEB-19
Rev.	Description	Date

PART NO.	SHEET	OF
----------	-------	----



www.spectrum-semi.com Phone: 408-435-5555 Fax: 408-435-8226

SSM P/N CPG14446

NTK

LATEST REVISION'S DESCRIPTION

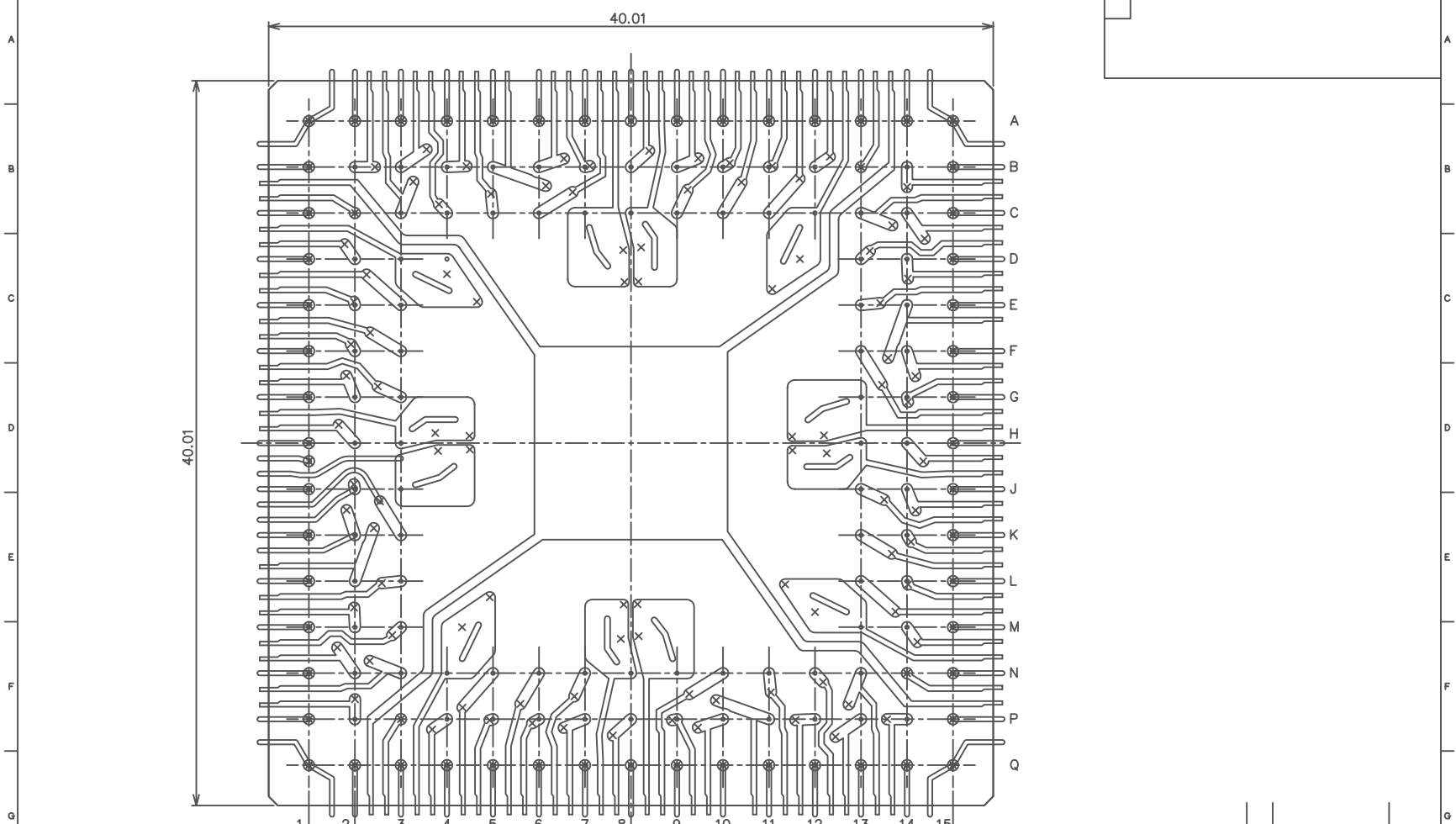

MODIFIED
DWG NO.

DESCRIPTION	DRAWN	N.KAWAI	NEW DRAWING	FEB-19
FILE NAME	CHECKED		Rev.	Description
CUSTOMER	APPROVED		Date	
DWG NO.	UNIT	MM [INCH]	TITLE	
	SCALE		D/A PATTERN	
			DWG NO.	
			P-IPK-8573A-1	

PART NO. SHEET OF



SSM P/N CPG14446

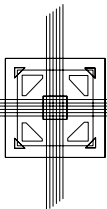
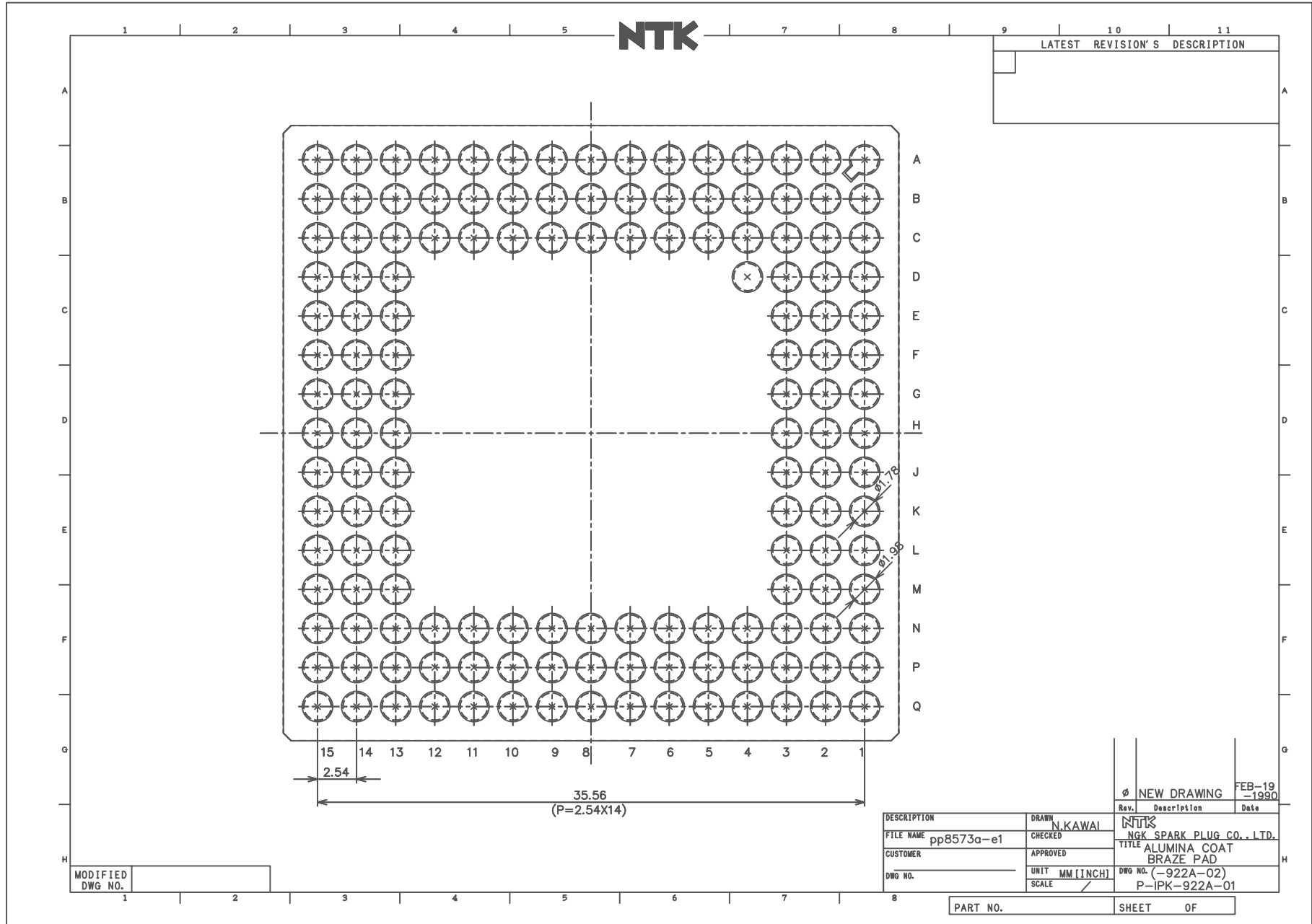

SPECTRUM
SEMICONDUCTOR MATERIALS, INC.

www.spectrum-semi.com Phone: 408-435-5555 Fax: 408-435-8226